

4HS MultiPower

**4" submersible
pumps powered by
renewable energy
sources**



SOLAR PUMPTEC
SOLAR PUMPING SPECIALISTS



nastec.eu

NASTEC[®]
> we move it faster >

4HS MultiPower pumps powered by renewable energy sources, is a new range from 4HS pumps with built-in inverter.

4HS MultiPower pumps can be powered by AC or DC with a wide range of operating voltage (90 - 265 VAC / 90 - 400 VDC). This means that 4HS MP pumps can be connected to solar panels, batteries, wind turbine and a diesel generator.

A special software algorithm allows for adjusting the hydraulic performance to each source and to the available power while maximizing the amount of water pumped.

All the advantages of built-in electronics

The built-in electronics inside the motor avoid the use of shielded cables and output filters, and it is the ideal solution for any application in remote

locations without surveillance and climatically adverse.

In fact, in the traditional solutions, the solar inverter is placed

above ground and, being exposed to the weather, could suffer of:

- Overheating
- Water infiltration
- Thermal shock
- Damage by animals or people

The built-in electronics are directly cooled by the water flow; the operating temperature of the electronic components is so low as to ensure considerably longer life than a surface inverter affected by high temperatures, humidity, dust and sunlight.

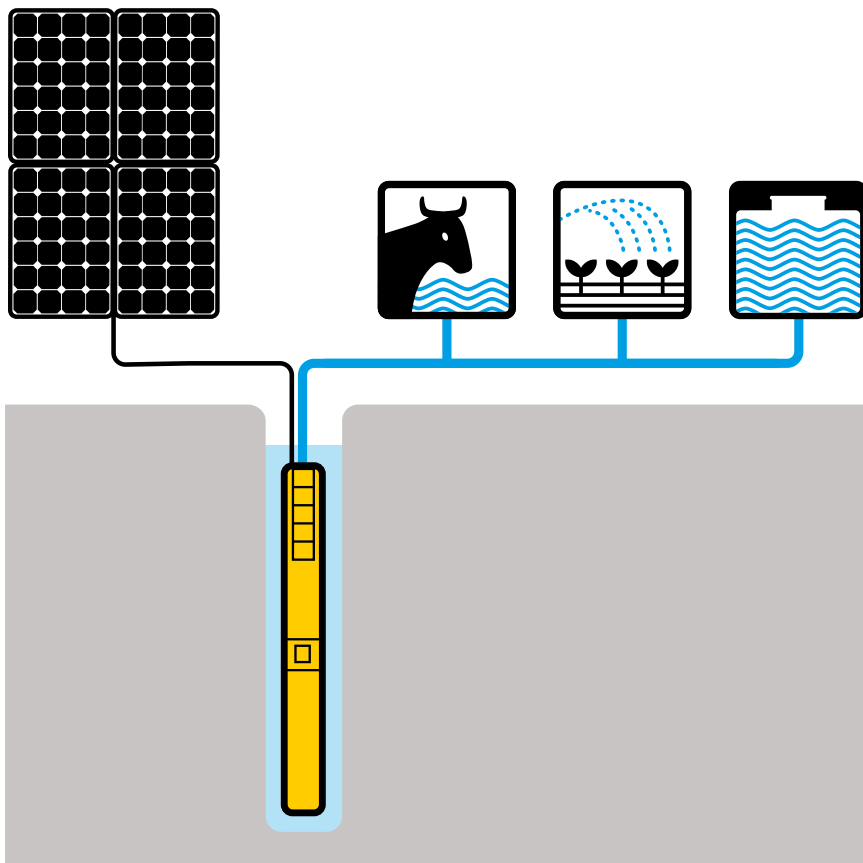

SOLAR PUMPTEC
SOLAR PUMPING SPECIALISTS

4HS MultiPower pump can be installed with CM MultiPower control module or without it, thus becoming a “plug and pump” system.



If the CM MultiPower control module is not used, signal cables can be used to

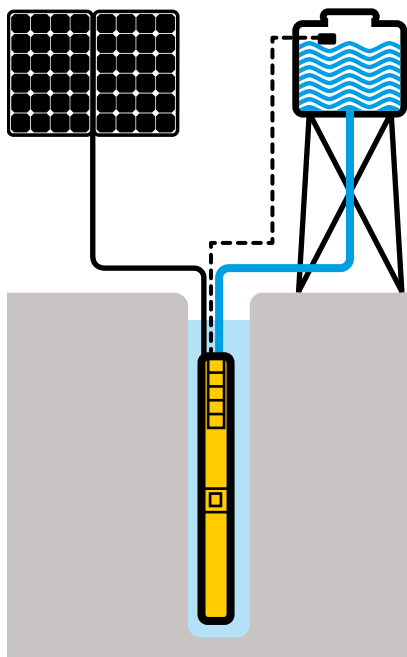

control pump start and stop, connecting a float switch, for example. All the protections against overload, surges and dry running are integrated into the on-board inverter.

If the signal cables are connected to the CM MultiPower control module, it is possible to:

- Control the electric parameters (current, power, voltage).
- Record and store all the alarms related to the working hours.
- Connect a pressure or a flow sensor to monitor the pump's performance.
- Connect a pressure or float switch.
- Provide an alarm digital output for remote control.

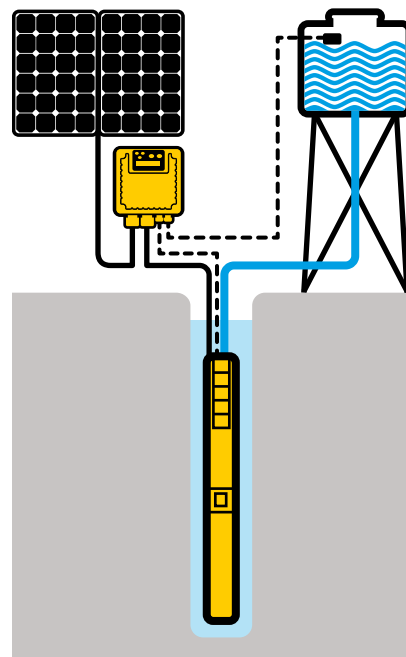

Use of auxiliary genset

If solar energy is absent or insufficient, it is possible to power the pump with an auxiliary genset to achieve the desired pump performance.

An AC/DC selector is used to change the power source.

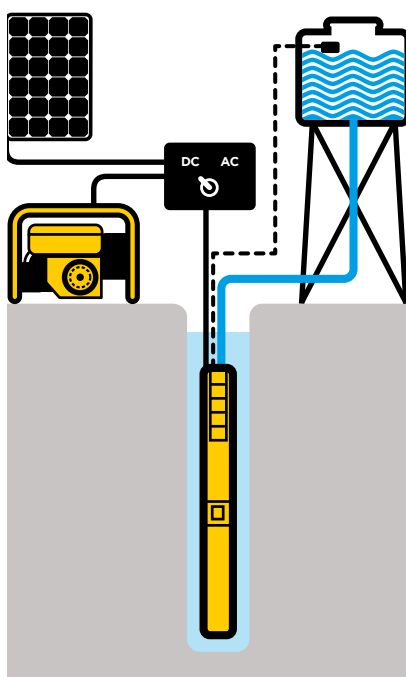

Integrated on-board protection

Protection against overload, surges and dry running are integrated into the pump's electronic circuit.

Electronic protection against dry running avoids the use of probes.

MPPT: always the maximum power available

Based on the varying conditions of solar irradiation and temperature, MPPT (Maximum Power Point Tracking) maximises the electrical power drawn from the panels and therefore the amount of water pumped.

The greater the solar irradiation the faster the pump's rotation speed, and consequently water flow increases.

When solar irradiation decreases (due to clouds or the different times of day), the pump reduces frequency and therefore the flow, but it continues to provide water until the irradiation falls below a minimum level necessary to ensure operation.

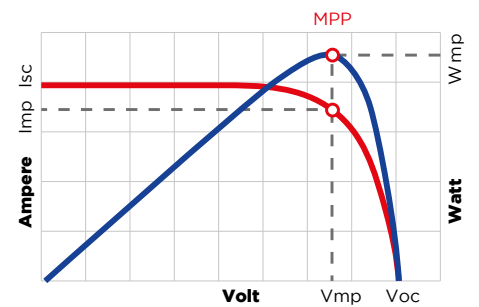

Centrifugal pump

- Impellers and diffusers in stainless steel.
- Built-in no-return valve.



Motor

- Permanent magnet motor.
- Resined and incapsulated stator made of AISI 304 stainless steel.
- Water-cooled rotor.
- Kingsbury thrust bearing.



Built-in inverter module (MINT)

- Completely resin-filled.
- Removable power cable.





The helical rotor pump

4HS "H" pumps are equipped with a helical rotor that moves within a double-helix rubber stator.

The rotor is made of AISI 304 stainless steel and coated with a hard chrome surface.

During operation, the rotor moves on the rubber surface and is lubricated by the pumped water.

The flow rate is directly proportional to the pump speed while the pressure supplied is kept almost constant.

In this way, unlike a centrifugal pump, the helical rotor pump provides high head even at low rpm, ensuring water on surface even with very low available power or low solar irradiation.

In addition, the helical rotor pumps feature higher hydraulic

efficiency than centrifugal pumps having the same flow. This saves in the number of solar panels necessary for the application.



Permanent magnet motor

4HS MP pumps are equipped with a permanent magnet motor.

The rotor uses Neodymium magnets coated with thin layers of copper and nickel to ensure greater reliability and durability in addition to superior magnetic performance.

High motor efficiency and starting torque make it possible for the pump to run even in low-light conditions.

The integrated inverter module converts DC energy into useful electrical energy to drive the motor efficiently and, at the same time, adjusts the pump

speed according to the available irradiation, maximising the power extracted (MPPT).

Overload, overheating, dry-run protections are integrated on board.

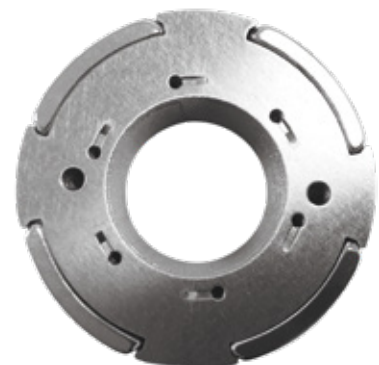

Pump selection

For the correct selection of a 4HS MultiPower pump to be used in a photovoltaic system, it is necessary to know:

- Desired daily water quantity
- Total dynamic head
- Installation location

Based on location it is possible to calculate average daily radiation [kWh/m²/day]. Average

daily radiation can then be considered as the number of hours the pump works with 1 kW/m², the value of reference for defining solar panel performance.

Dividing the required water quantity by the hours, nominal flow is calculated and, in addition to the required head, the right pump can be selected.

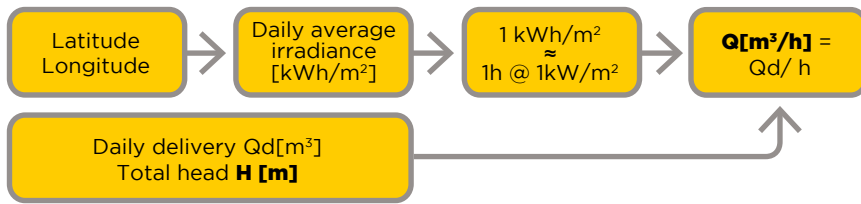

For a full sizing of your solar pumping system, it is recommended using Nastec Solar Calculator (NSC) at:

solar.nastec.eu



Performance

4HS 01/03H MP

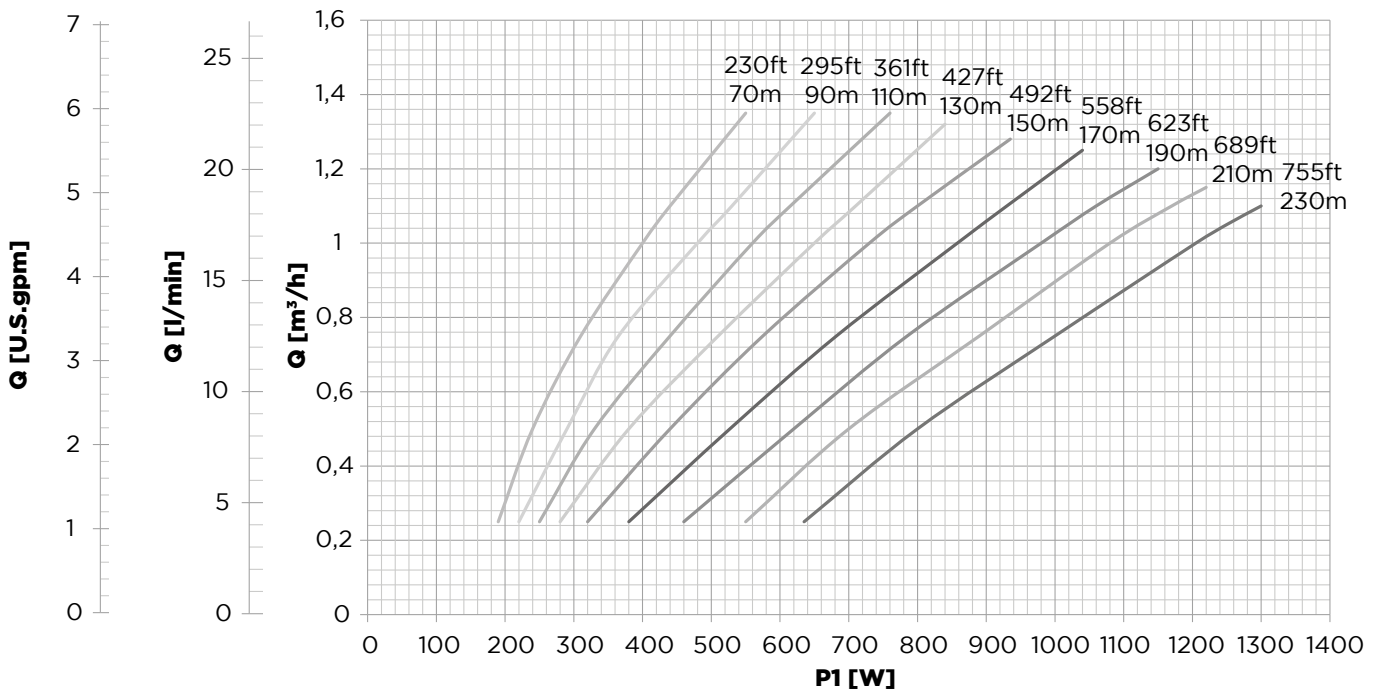

Model	Voltage	Max current	Power factor	Max power	Length	Discharge	Pump weight	Max diameter*	Packing dimensions	Total weight
4HS		[A]		P1 [W]	[mm]		[kg]	[mm]	[cm]	[kg]
01/03H MP	90-400 VDC 90-265 VAC	13 (100 VDC) 13 (100 VAC)	1	1300	1385	1 1/4"	21	99 *	120x20x29	22

* Max external diameter including cable and cable cover



SOLAR PUMPTec
SOLAR PUMPING SPECIALISTS

Performance

4HS 02/02H MP

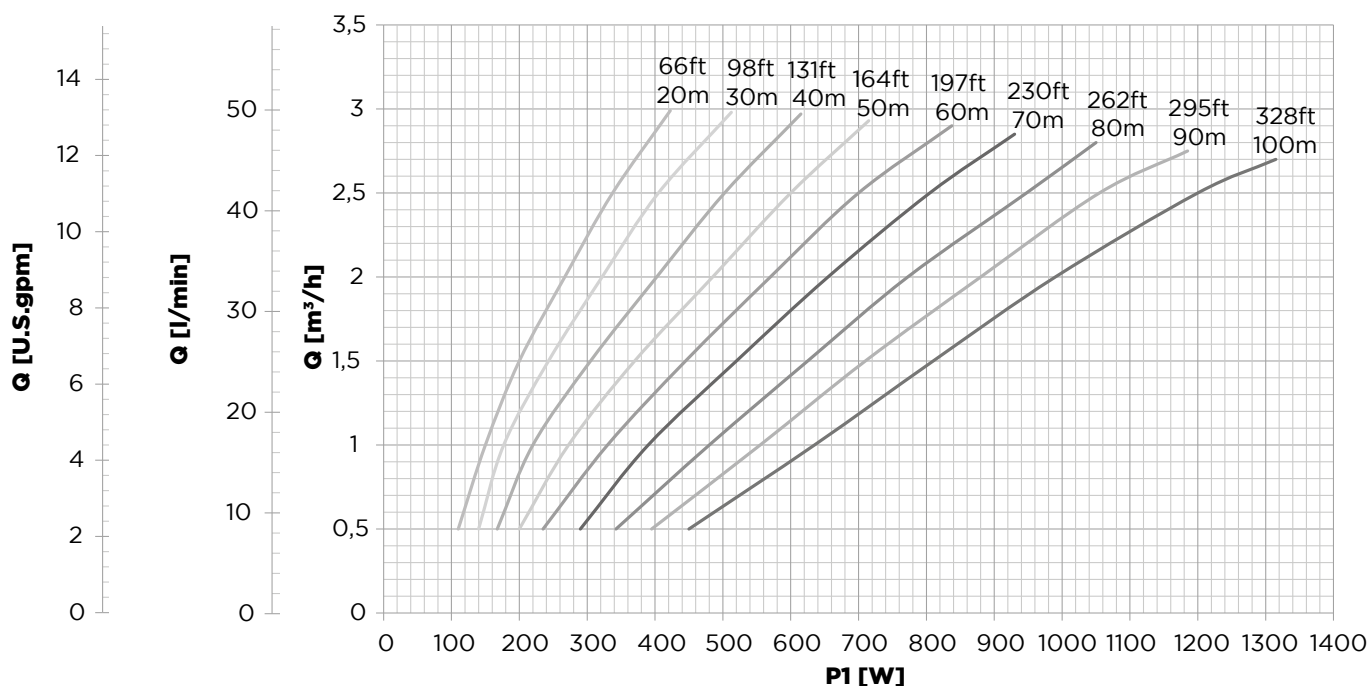

4HS 02/02H R MP

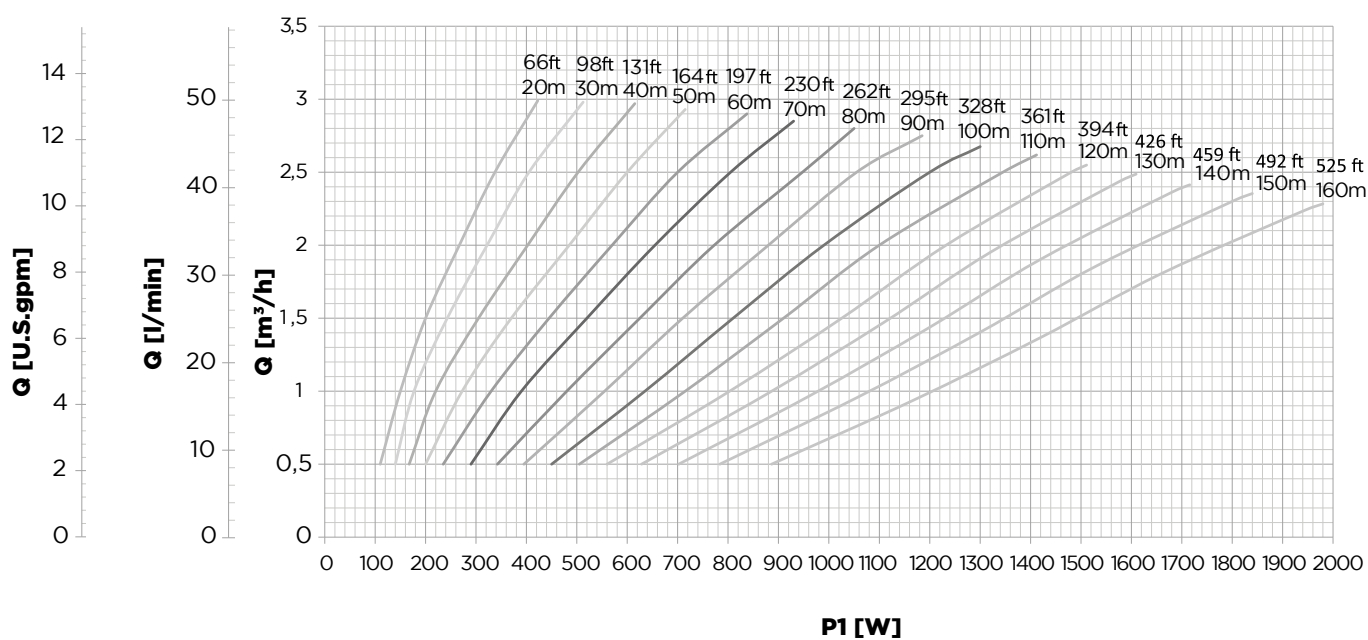

Model	Voltage	Max current	Power factor	Max power	Length	Discharge	Pump weight	Max diameter*	Packing dimensions	Total weight
4HS		[A]		P1 [W]	[mm]		[kg]	[mm]	[cm]	[kg]
02/02H MP	90-400 VDC 90-265 VAC	13 (100 VDC) 13 (100 VAC)	1	1300	1350	1 1/4"	19,5	99 *	120x20x29	20,5
02/02HR MP	90-400 VDC 90-265 VAC	16 (125 VDC) 16 (125 VAC)	1	2000	1400	1 1/4"	20,5	99 *	120x20x29	21,5

* Max external diameter including cable and cable cover

Performance

4HS 05/04 MP

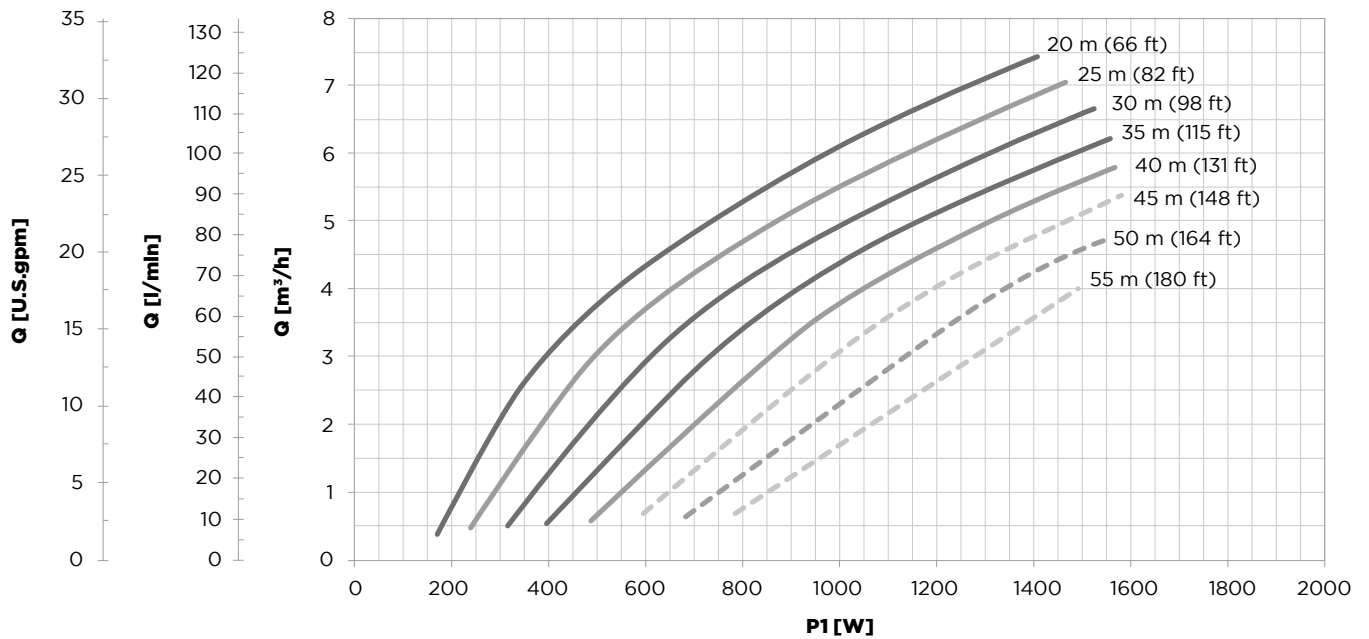

4HS 05/08 MP

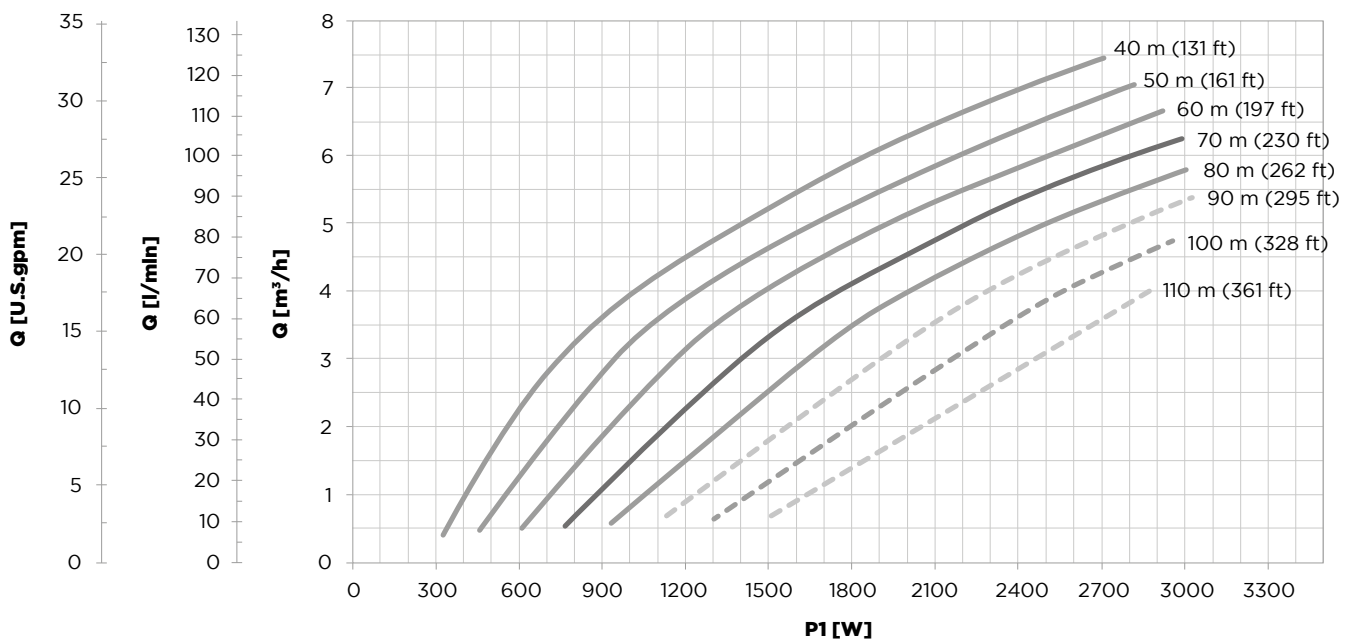

CM MultiPower installation is recommended for points of operation on the dashed lines.

Model	Voltage	Max current	Power factor	Max power	Length	Discharge	Pump weight	Max diameter*	Packing dimensions	Total weight
4HS		[A]		P1 [W]	[mm]		[kg]	[mm]	[cm]	[kg]
05/04 MP	90-400 VDC 90-265 VAC	16 (100 VDC) 16 (100 VAC)	1	1600	879	1 1/2"	19,5	99 *	120x20x29	20,5
05/08 MP	90-400 VDC 90-265 VAC	16 (187 VDC) 16 (187 VAC)	1	3000	1013	1 1/2"	22	99 *	120x20x29	23

* Max external diameter including cable and cable cover

Performance

4HS 08/03 MP

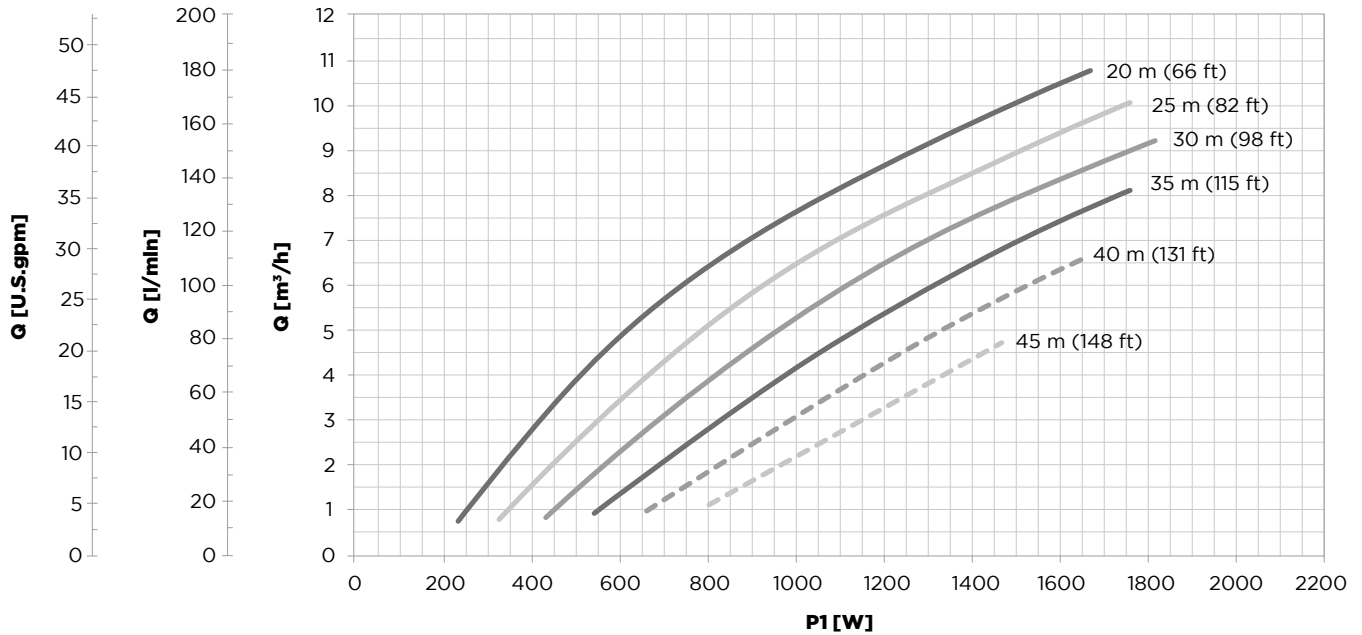

4HS 08/05 MP

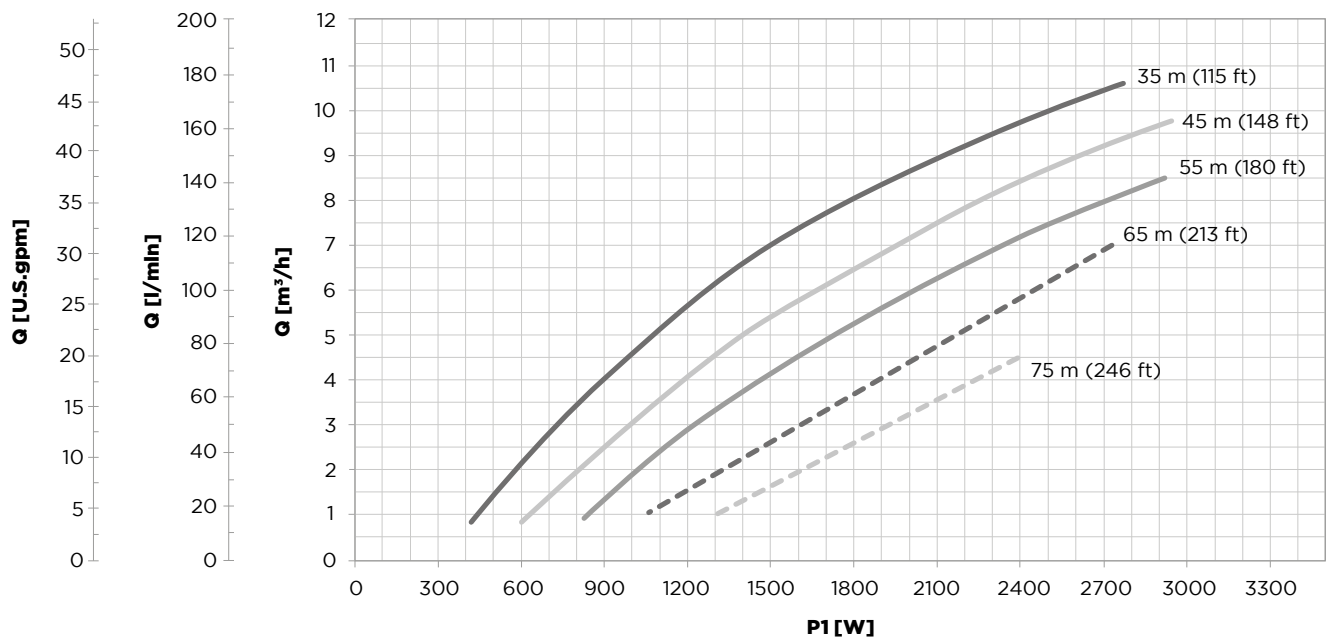

CM MultiPower installation is recommended for points of operation on the dashed lines.

Model	Voltage	Max current	Power factor	Max power	Length	Discharge	Pump weight	Max diameter*	Packing dimensions	Total weight
4HS		[A]		P1 [W]	[mm]		[kg]	[mm]	[cm]	[kg]
08/03 MP	90-400 VDC 90-265 VAC	16 (113 VDC) 16 (113 VAC)	1	1800	858	1 1/2" 2"	19,4	99 *	120x20x29	20
08/05 MP	90-400 VDC 90-265 VAC	16 (187 VDC) 16 (187 VAC)	1	3000	950	1 1/2" 2"	21	99 *	120x20x29	22

* Max external diameter including cable and cable cover

Materials

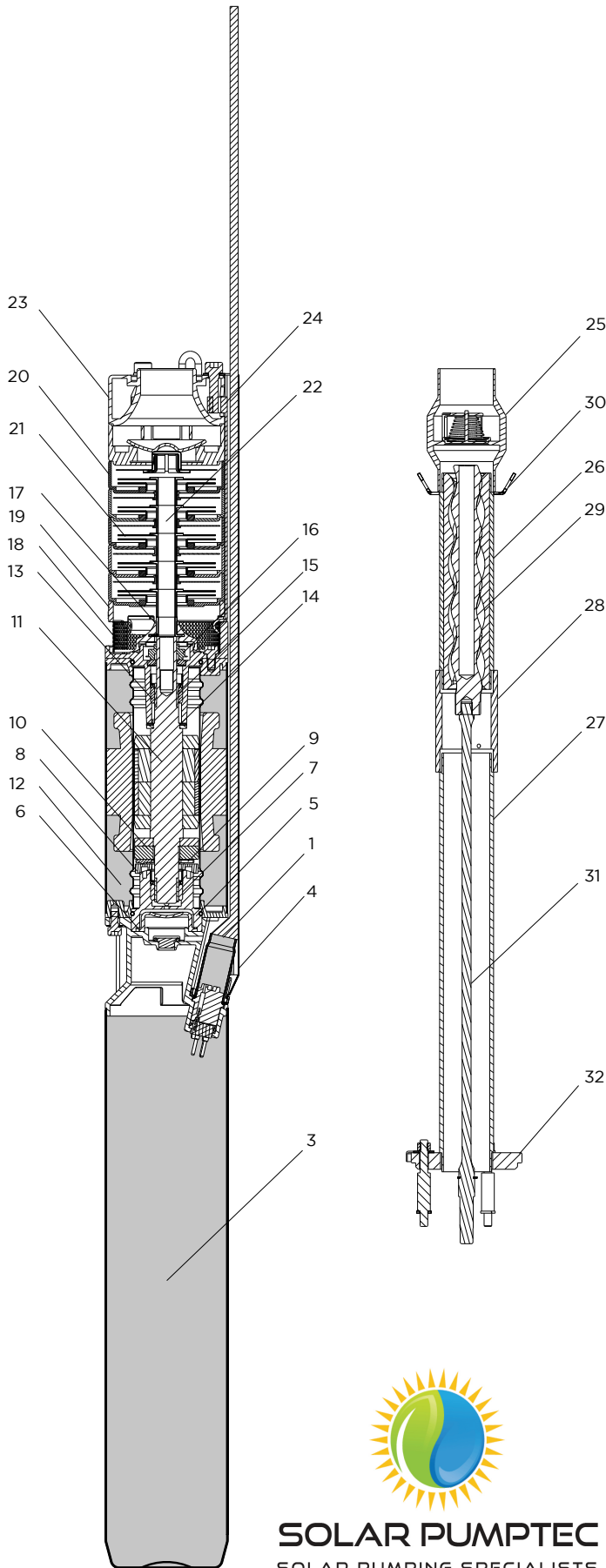

Ref	Description	Material
1	Power supply cable with removable connector for drinking water applications	AISI 304 + ACS-KTM-WRAS compliant
3	MINT: Electronic Integrated Module	
4	Cable guard	AISI 304
5	Lower thrust bearing	AISI 304
6	Rubber diaphragm	EPDM
7	Lower bush	SiC
8	Tilting disc	AISI 304
9	Pads	AISI420j
10	Carbon disc	CTI25
11	Shaft with rotor	AISI 431
12	Canned type stator	AISI 304
13	Upper bush	SiC
14	Upper thrust bearing	Teflon
15	Ceramized sleeve	AISI 304 + Ceramic
16	Mechanical seal	SiC
17	Rotating sandguard	NBR
18	Pump filter	AISI 304
19	Pump bracket	AISI 304
Centrifugal pump		
20	Diffusers	AISI 304
21	Impellers	AISI 304
22	Pump shaft	AISI 304
23	Discharge	AISI 304
24	Straps	AISI 304
Helicoidal rotor pump		
25	No-return valve	AISI 304
26	Helicoidal stator	EPDM + AISI 304
27	Supporting pipe	AISI 304
28	Junction	AISI 304
29	Helicoidal rotor	AISI 304 cromed
30	Safety hook	AISI 304
31	Flexible shaft	AISI 316
32	Pump adaptor	AISI 304



SOLAR PUMPTEC
SOLAR PUMPING SPECIALISTS

General specifications

4HS MultiPower	
Max liquid temperature	35°C (92°F)
Min liquid cooling speed	0.2 m/s
Characteristics of the pumped liquid	clean, chemically not aggressive, not explosive, without solid and fibre content, with max 50 g/m ³ sand content
Protection grade	IP68
Maximum immersion depth	150 m
Materials	Motor and pump in AISI 304 stainless steel
Cable	Flat cable ACS - WRAS - KTM approved
CM MultiPower Control Module	
Max ambient temperature	50°C (122°F)
Protection grade	IP55
Materials	Aluminium enclosure, PVC labels , cable gland in polyamide (PA), display membrane in polyester (PE)
Analog input	2 input 4-20 mA + 2 input 4-20 mA or 0-10 V settable by the user
Digital input	4 input N.O or N.C settable by the user
Digital output	2 relays output 5 A , 250 VAC, N.O or N.C settable by the user
User display	display LCD backlit, 16 characters x 2 rows, 5 buttons
Short-circuit protection	fuse

Certifications	
CE	

4HS MultiPower pump can be installed both vertically and horizontally, as long as the outlet is never lower than the horizontal axis.

To ensure proper cooling if 4HS is not installed in a 4" well, it is necessary to use a cooling sleeve.

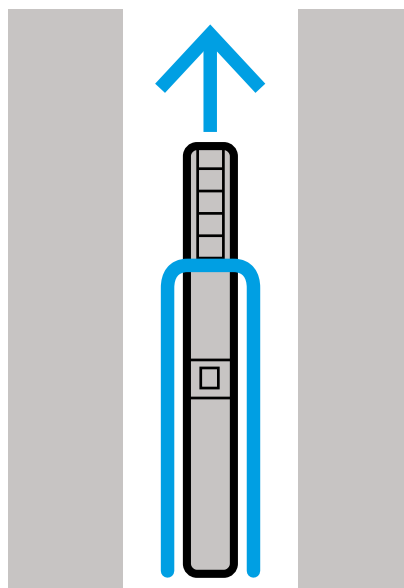
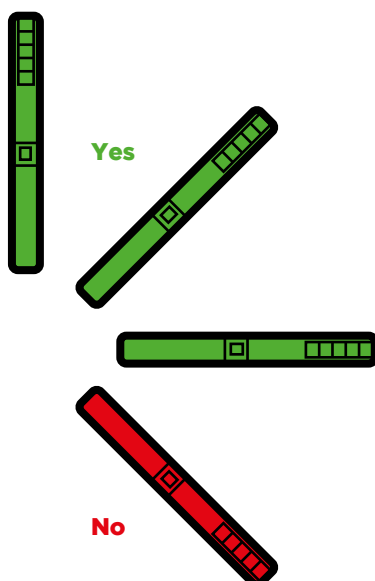

SOLAR PUMPTEC
SOLAR PUMPING SPECIALISTS

Nastec srl

Via della Tecnica 8
36048 Barbarano Mossano
Vicenza - Italy

tel +39 0444 886289
fax+39 0444 776099
info@nastec.eu

nastec.eu



SOLAR PUMPTEC
SOLAR PUMPING SPECIALISTS

Unit 1 & 2, 1 Theen Ave
Willaston SA 5118

Phone (08) 8522 2762
0447 652 762
0499 771 880

sales@solarpumpte.com.au

solarpumpte.com.au